

Evaluation of Subsystem Clock Oscillation Circuit

[uPD78F0138M2GB-8EU] LQFP(10x10) 0.5mm pitch

Measurement conditions : 5.0V (In use of regulator), 5.0V (Non use of regulator)



Model	:SSP-T7
Frequency	:Fo=32.768kHz
Frequency tolerance	:dF/Fo= +/-20x10 ⁶
Load capacitance	:CL=7.0pF
Equivalent series resistance	:R1=65kohm max
Max. Drive level	:DL=x10 ⁻⁶ W max
Recommended drive level	:DL=0.1x10 ⁻⁶ W typ

FEATURES

- 1.Ultra thin type with 1.4mm Max.
- 2.SMD type suitable for automatic & high density surface mounting.
- 3.Plastic mold package containing highly reliable tubular type quartz crystal.
- 4.Excellent shock and heat resistance.
- 5.Cellular phones,PDA,Radio communication equipment, Portable applications etc.

RECOMMENDED SOLDERIN PATTERN

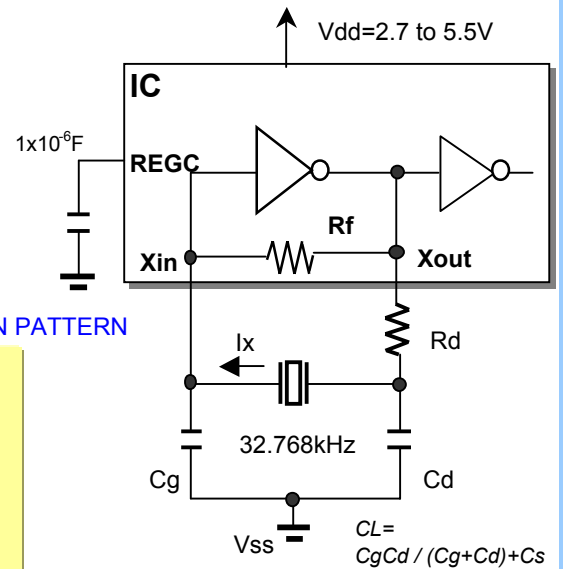
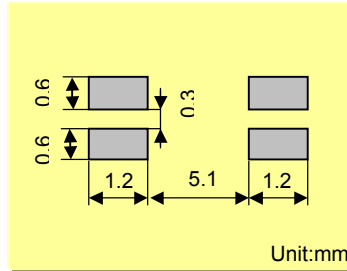

Remark) I_x : current through crystal

When the internal power supply Step-Down circuit is not used, please connect the external power supply to the REGC pin and Vdd pin.

MODEL:SSP-T7 7.0pF with uPD78F0138M2GB at 5.0V,25°C

Key specifications	Non use	In use(REG)	Remarks
Current control resistance : Rd (k ohm)	330	330	Control drive level & secure phase margin
Capacitance at gate : Cg (pF)	8	6	Optimal capacity in response to CL
Capacitance at drain : Cd (pF)	8	6	(CL = Cd // Cg + stray capacitance)

Circuit characteristics (at 25°C)	Non use	In use(REG)	Remarks
Matching Accuracy : df / f ($\times 10^{-6}$)	-2.6	-1.8	Frequency offset volume at specified Vdd
Voltage Fluctuation : $\pm df / V$ ($\times 10^{-6}$)	4.1	0.0	Vdd $\pm 10\%$ (Standard operating voltage range)
Drive Level : DL ($\times 10^{-6}$ W)	0.19	0.12	$DL = I_x^2 R_e < 1 \times 10^{-6}$ W, $R_e = R_1(1 + C_o / CL)^2$
Negative resistance : $ -RL $ (kohm)	870	730	5 times larger than R_{1MAX}
Oscillation allowance : M (times)	13.4	11.2	Judgemental standard of oscillation stability
Oscillation start up time : Ts (sec)	0.60	0.62	Time to reach 90% of output level

Temperature characteristics of circuit	Non use	In use(REG)	Remarks	
at -40°C	Variation : df / T ($\times 10^{-6}$)	-134	-135	Typ.Tp=25°C (K = $-3.5 \times 10^{-8} / ^\circ\text{C}^2$)
at +85°C	Variation : df / T ($\times 10^{-6}$)	-139	-138	Typ.Tp=25°C (K = $-3.5 \times 10^{-8} / ^\circ\text{C}^2$)

The mention value is only for your reference. The value is for the arbitrary samples and does not guarantee the product's characteristics. Please review and check above parameters at customer's end.

Seiko Instruments USA Inc.

2990,West Lomita Blvd., Torrance, CA 90505, U.S.A
 Telephone :+1 310-517-7771 Facsimile :+1 310-517-7792
 Email :crystals@siu-la.com

Seiko Instruments GmbH

Siemensstrasse 9,D-63263 Neu-Isenburg,Germany
 Telephone :+49-6102-297-0 Facsimile :+49-6102-297-320
 Email :info@seiko-instruments.de

Seiko Instruments Inc.

1-8,Nakase,Mihama-ku,Chiba-shi,Chiba 261-8507,Japan
 Facsimile :+81-43-211-8030 E-mail :component@sii.co.jp



We value the "takumi" spirit.

Seiko Instruments Inc.

Phone:+81-43-211-1207(Direct)

Evaluation of Subsystem Clock Oscillation Circuit

[uPD78F0138M2GB] LQFP(10x10) 0.5mm pitch

Measurement conditions : 5.0V (In use of regulator), 5.0V (Non use of regulator)



Test Data

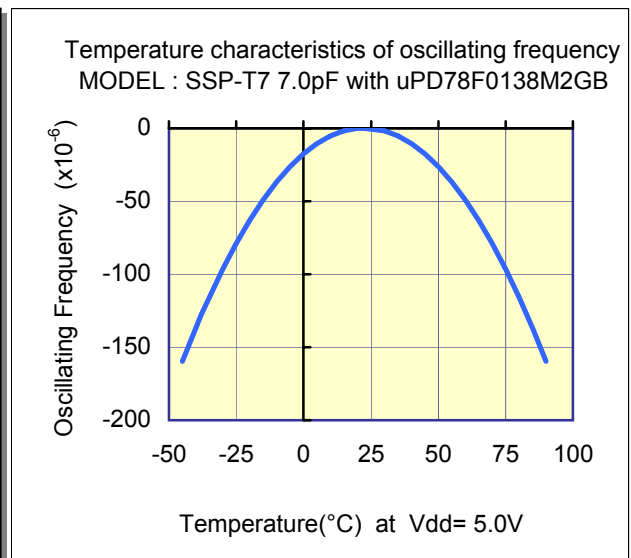
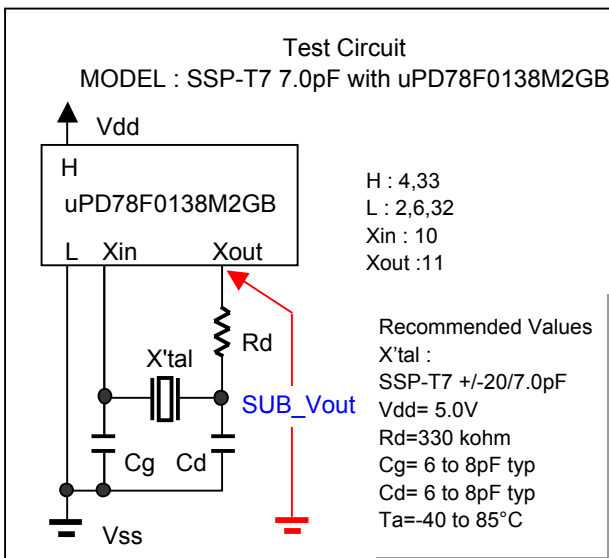
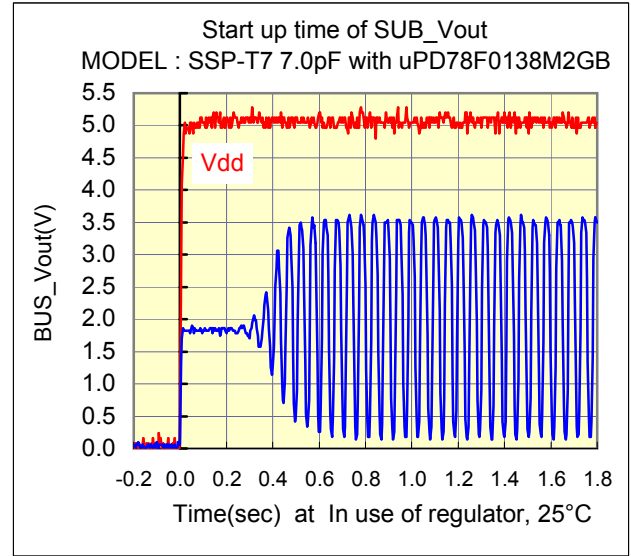
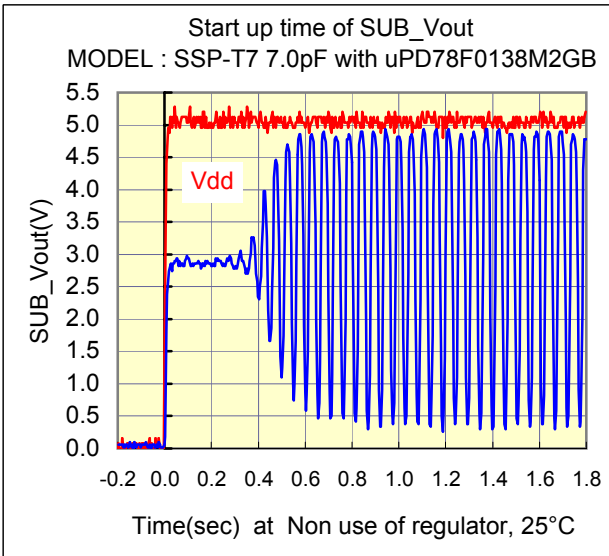
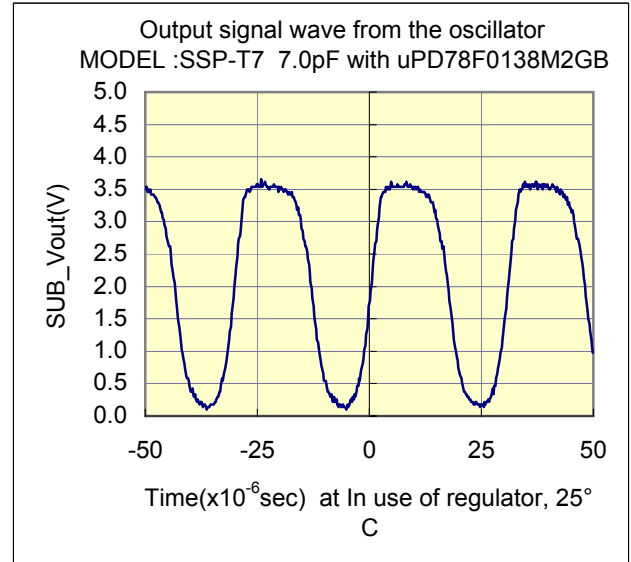
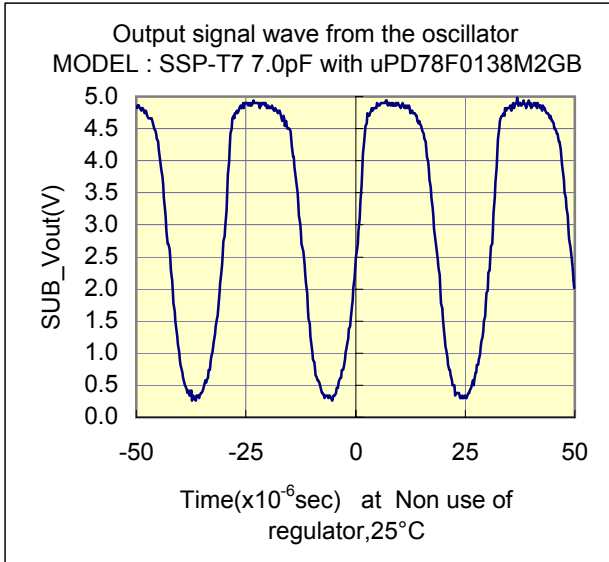

Evaluation of Subsystem Clock Oscillation Circuit

[uPD78F0138M2GB-8EU] LQFP(10x10) 0.5mm pitch

Measurement conditions : 5.0V (In use of regulator), 5.0V (Non use of regulator)



Test Data : Temperature characteristics

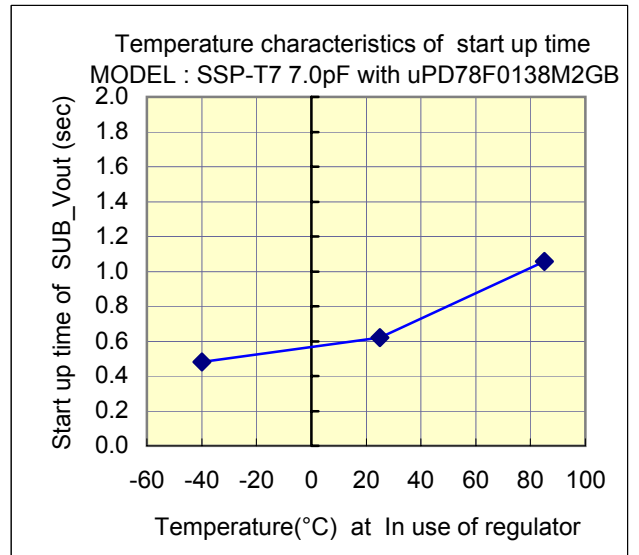
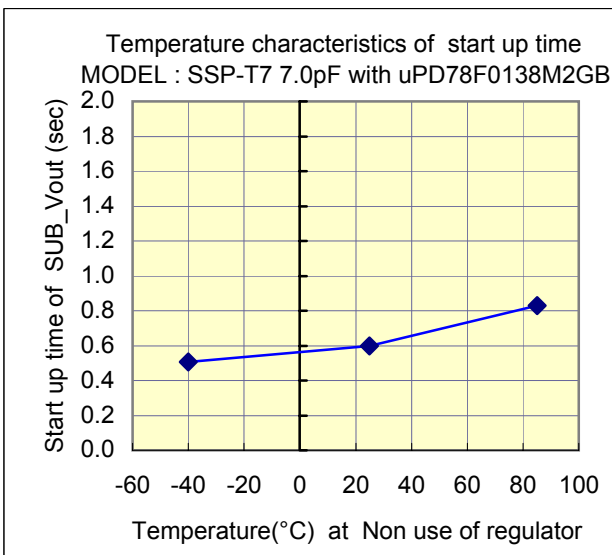
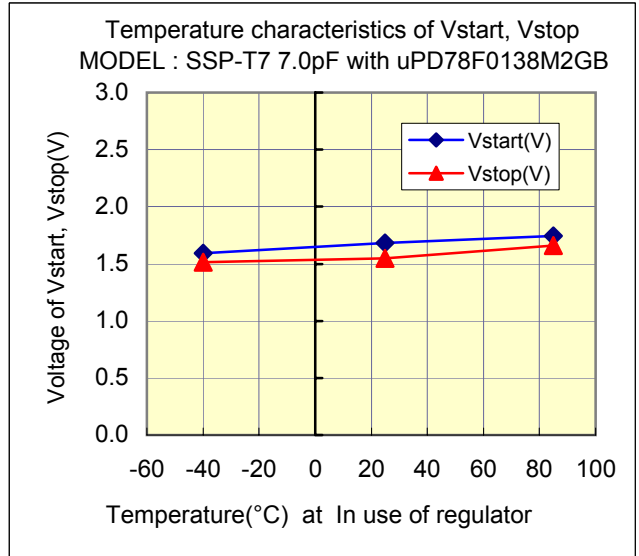
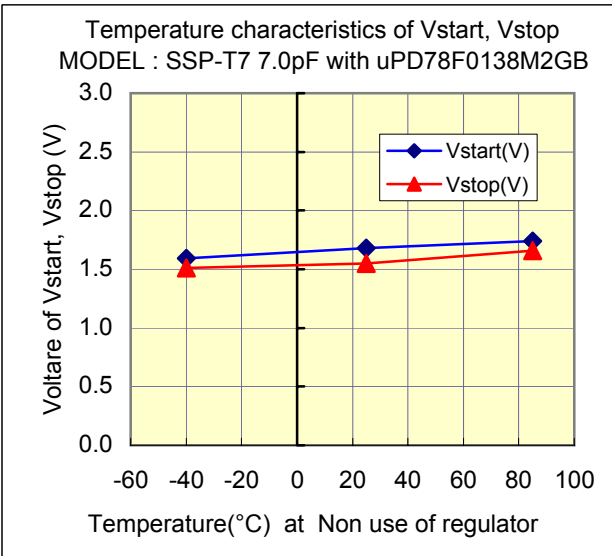
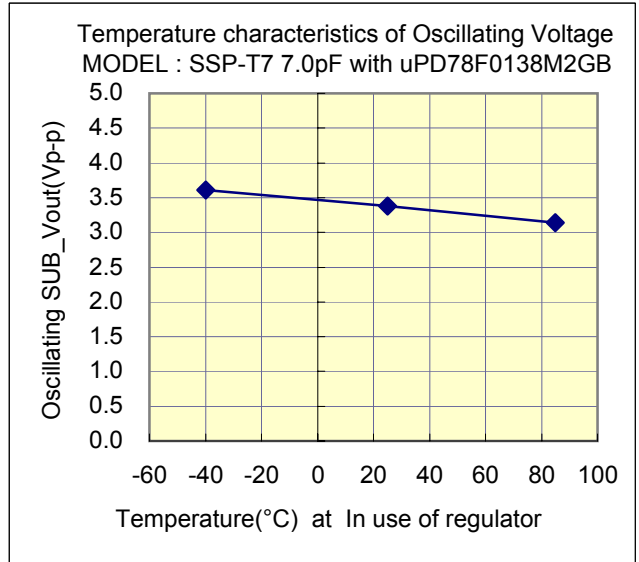
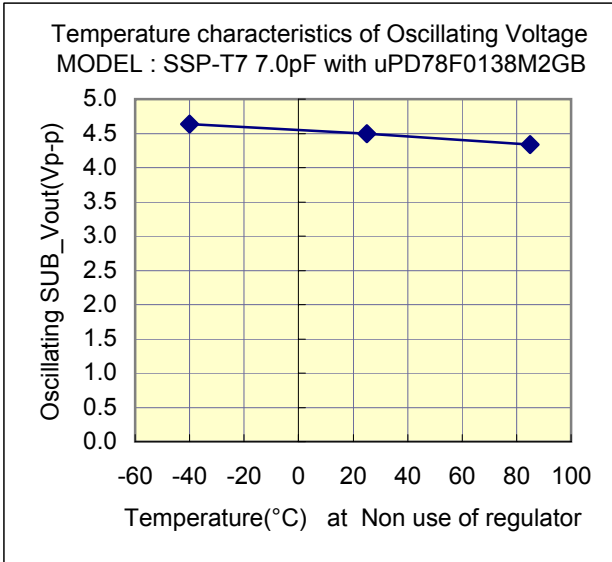

Evaluation of Subsystem Clock Oscillation Circuit

[μ PD78F0138M2GB-8EU] LQFP(10x10) 0.5mm pitch

Measurement conditions : 5.0V (In use of regulator), 5.0V (Non use of regulator)



Referencial components layout(see Figure 1)

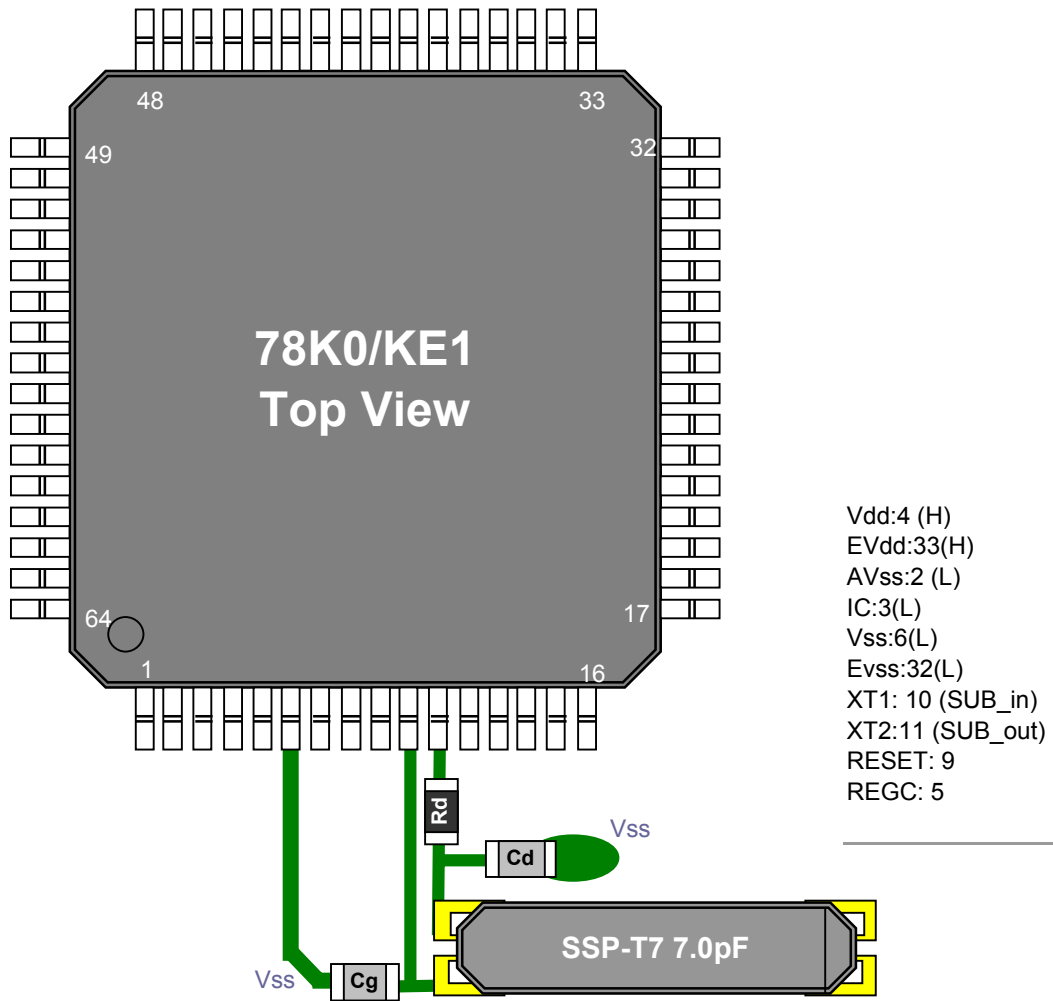

Figure 1 Referencial components layout

Notes Board Design

When using a crystal resonator, place the resonator and its load capacitors as close as possible to SUB_in and SUB_out pins.

Other signal lines should be routed away from the resonator circuit to prevent induction from interfering with correct oscillation (see figure 2).

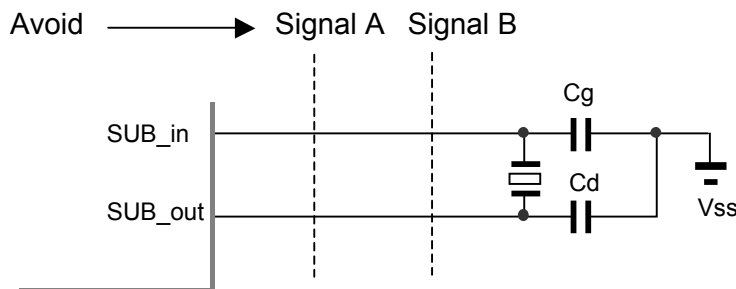

Figure 2 Example of Incorrect Board Design

Remak When using the subsystem clock, insert resistors Rd in series on the SUB_out side.

Evaluation of Subsystem Clock Oscillation Circuit

[uPD78F0138M2GB-8EU] LQFP(10x10) 0.5mm pitch

Measurement conditions : 5.0V (In use of regulator), 5.0V (Non use of regulator)



[Evaluation Sample : SSP-T7 7.0pF at 25°C]

SAMPLE	No.	CL (pF)	Fo (Hz)	fr (Hz)	R1 (kohm)	Co (pF)	C1 (fF)	Q (k)
SSP-T7 7.0pF	1	7	32768.55	32764.38	39.6	0.84	1.994	61.5
	2	7	32768.40	32764.24	37.8	0.83	1.987	64.7
	3	7	32767.88	32763.63	39.2	0.85	2.037	60.9

[IC Test Data : IC Sampl Rd=330kohm,Cg=6pF,Cd=6pF at 25°C]

Regulator	IC Sampl	Fosc (Hz)	df / f (x10 ⁻⁶)	DL(x10 ⁻⁶ W)	-RL (kohm)	Vstart (V)	Ts(sec)
In use	typ-#01	32768.49	-1.83	0.12	729.6	1.68	0.62
	typ-#02	32768.48	-2.14	0.12	729.6	1.68	0.64
	typ-#03	32768.49	-1.83	0.12	729.6	1.67	0.64

[IC Test Data : IC Sampl Rd=330kohm,Cg=8pF,Cd=8pF at 25°C]

Regulator	IC Sampl	Fosc (Hz)	df / f (x10 ⁻⁶)	DL(x10 ⁻⁶ W)	-RL (kohm)	Vstart (V)	Ts(sec)
Non use	typ-#01	32768.47	-2.59	0.19	869.6	1.68	0.60
	typ-#02	32768.47	-2.44	0.19	869.6	1.68	0.58
	typ-#03	32768.46	-2.75	0.19	869.6	1.67	0.58

Remak (see figure 3)

$$F_o = f_r \times \left\{ \frac{C_1}{2 \times (C_o + C_L)} + 1 \right\} \text{ (Hz)}$$

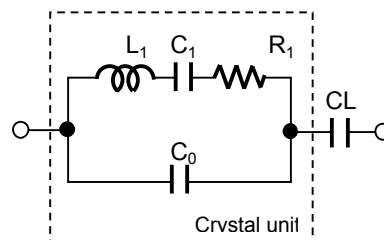

Fo : Load resonance frequency
 fr : Resonance frequency
 R1 : Motional resistance
 C1 : Motional capacitance
 Co : Shunt capacitance
 CL : Load Capacitance

Figure 3 Equivalent circuit of crystal unit, and CL

Remak (see figure 4)

Approximate formula of the load capacitance of the circuit CL.

$$CL = C_g \times C_d / (C_g + C_d) + C_s \text{ (pF)}$$

Where Cs Stands for stray capacity of the circuit.

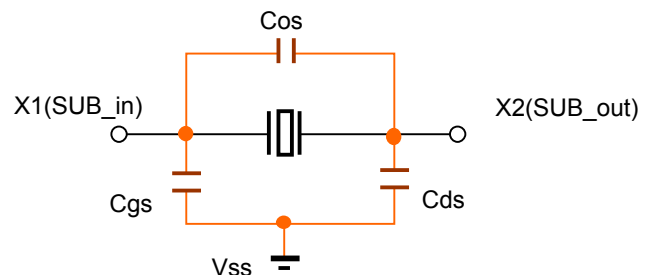

Cos : X1_X2 Stray capacitance
 Cgs : X1_Vss Stray capacitance
 Cds : X2_Vss Stray capacitance

Figure 4 Stray capacitance Cos,Cgs,Cds of the circuit

Resonator circuit constants will differ depending on the resonator element, stray capacitance in its interconnecting circuit, and other factors. Suitable constants should be determined in consultation with the resonator element manufacturer.