

Evaluation of a Low Frequency Clock Oscillation Circuit

SSP-T7-FL 6.0pF with R5F2L36CANFP-64P [LQFP(10x10) 0.50mm pitch]

Measurement conditions : 3.3V ,5.0V



New

SSP-T7-FL



Model :SSP-T7-FL
 Frequency :Fo=32.768kHz
 Frequency tolerance :dF/Fo= +/-20x10⁻⁶
 Load capacitance :CL=6.0pF
 Equivalent series resistance :R1=65kΩ max
 Max. drive level :DL=1μW max
 Level of drive :DL=0.01μW typ

FEATURES

- 1.Ultra thin type with 1.4mm Max.
- 2.SMD type suitable for automatic & high density surface mounting.
- 3.Plastic mold package containing highly reliable tubular type quartz crystal.
- 4.Excellent shock and heat resistance.
- 5.Cellular phones,PDA,Radio communication equipment, Portable applications etc.

RECOMMENDED SOLDERING PATTERN

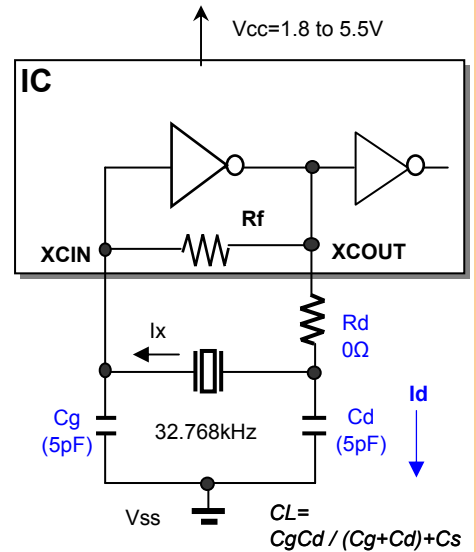
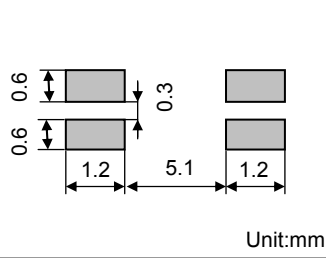

Remark) Ix : current through crystal

Low power consumption R8C/Lx and SSP-T7-FL 6.0pF

Xcin oscillation circuit consists of an excellent power saving circuit which realizes stable oscillation at low amplitude.

MODEL:SSP-T7-FL 6.0pF with R5F2L36CANFP at 25°C

Key specifications	Vcc=3.3V	Vcc=5.0V	Remarks
Current control resistance : Rd (k ohm)	0	0	Control drive level & secure phase margin
Capacitance at gate : Cg (pF)	5	5	Optimal capacitance in response to CL
Capacitance at drain : Cd (pF)	5	5	(CL = Cd // Cg + stray capacitance)

Circuit characteristics (at 25°C)	Vcc=3.3V	Vcc=5.0V	Remarks
Matching Accuracy : df / f (x10 ⁻⁶)	3.6	5.0	Frequency offset volume at specified Vcc
Voltage Fluctuation : +/-df / V (x10 ⁻⁶)	0.3	0.5	Vcc +/-10% (Standard operating voltage range)
Drive Level : DL (μW)	0.036	0.047	DL=Ix ² Re < 1x10 ⁻⁶ W,Re=R1(1 + Co / CL) ²
Negative resistance : - RL (kΩ)	904	1054	5 times larger than R _{1MAX}
Oscillation allowance : M (times)	14	16	Judgmental standard of oscillation stability
Low current consumption : Id (nA)	220	252	Cd charge current, Id = ωCd*Vd < 300nA
Voltage of oscillation start : Vstart (V)	1.23	1.23	
Voltage of oscillation stop : Vstop (V)	1.21	1.21	
Oscillation start up time : Ts (sec)	0.71	0.60	Time to reach 90% of output level, Ts < 1.0sec

Temperature characteristics of circuit		Vcc=3.3V	Vcc=5.0V	Remarks
at -40°C	Variation : df / T (x10 ⁻⁶)	-130	-130	Typ.Tp=25°C (K = -3.5x10 ⁻⁸ / °C ²)
at +85°C	Variation : df / T (x10 ⁻⁶)	-141	-141	Typ.Tp=25°C (K = -3.5x10 ⁻⁸ / °C ²)

The above mentioned value is only for your reference. The value is for the arbitrary samples and does not guarantee the product's characteristics. Please review and check above parameters at customer's end.

Seiko Instruments USA Inc.

2990,West Lomita Blvd., Torrance, CA 90505, U.S.A
 Telephone :+1 310-517-7771 Facsimile :+1 310-517-7792
 Email :info@siu-la.com

Seiko Instruments GmbH

Siemensstrasse 9,D-63263 Neu-Isenburg,Germany
 Telephone :+49-6102-297-0 Facsimile :+49-6102-297-320
 Email :info@seiko-instruments.de

Seiko Instruments Inc.

1-8,Nakase,Mihama-ku,Chiba-shi,Chiba 261-8507,Japan
 Facsimile :+81-43-211-8030
 E-mail :component@sii.co.jp



We value the "takumi" spirit.

Seiko Instruments Inc.
 Phone:+81-43-211-1207(Direct)

Evaluation of a Low Frequency Clock Oscillation Circuit

SSP-T7-FL 6.0pF with R5F2L36CANFP-64P [LQFP(10x10) 0.50mm pitch]

Measurement conditions : 3.3V ,5.0V



Low power consumption MPU

Test Data

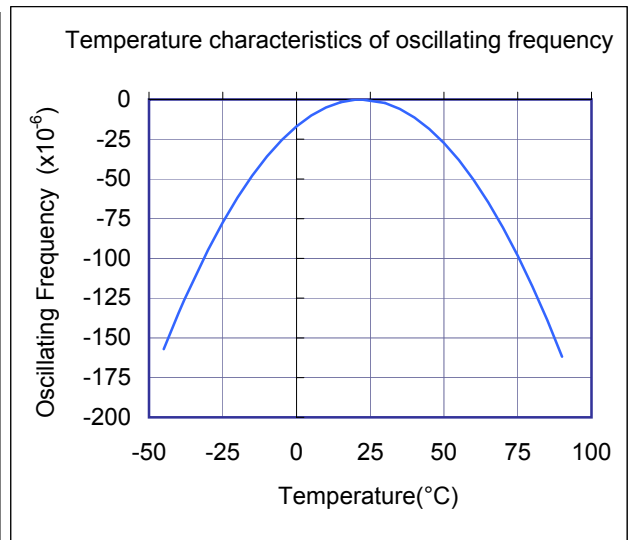
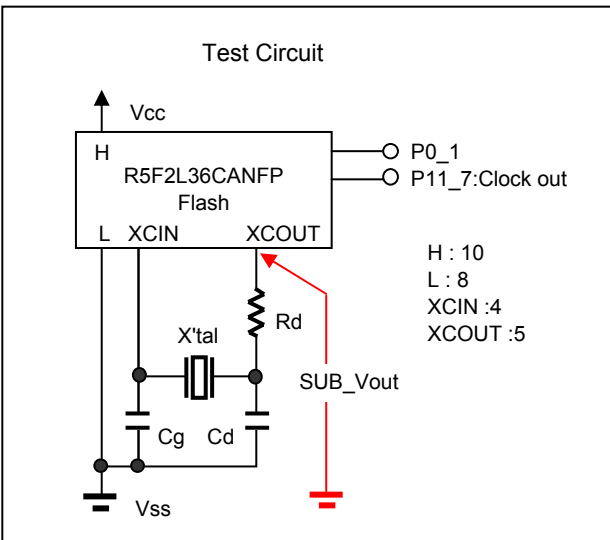
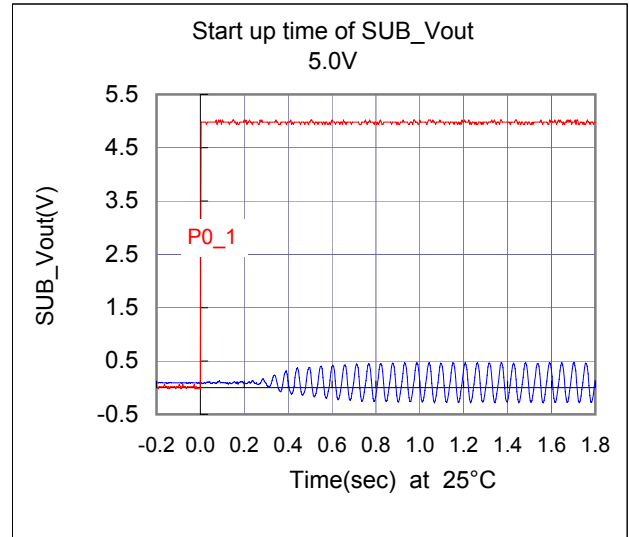
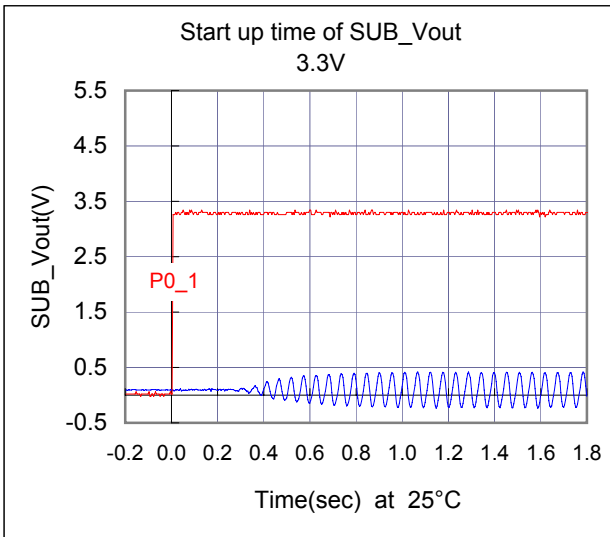
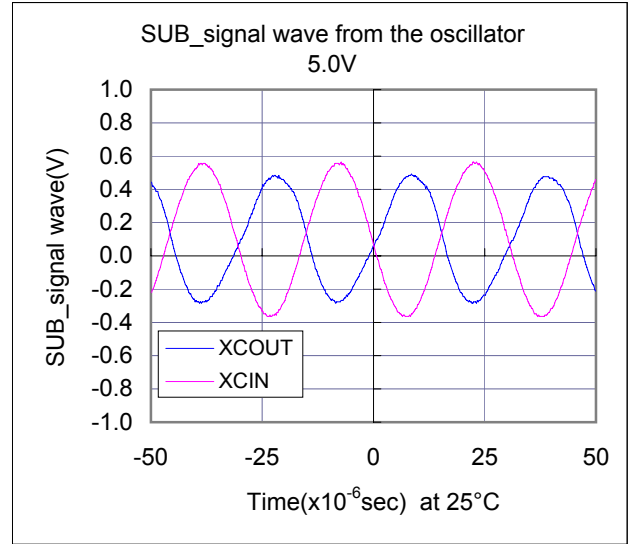
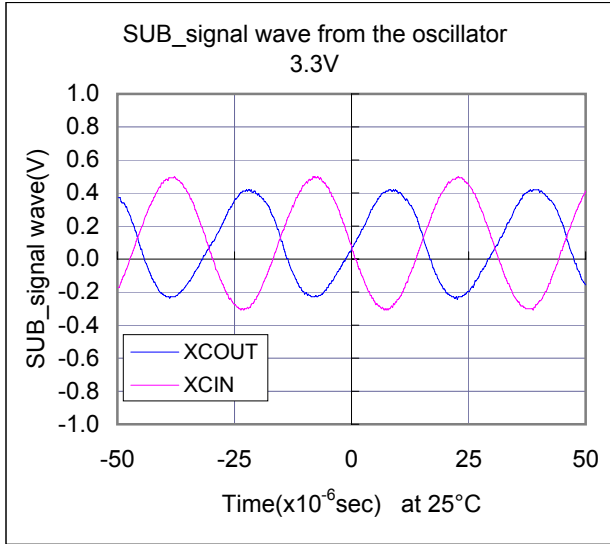

Evaluation of a Low Frequency Clock Oscillation Circuit

SSP-T7-FL 6.0pF with R5F2L36CANFP-64P [LQFP(10x10) 0.50mm pitch]

Measurement conditions : 3.3V ,5.0V



Low power consumption MPU

Test Data : Temperature characteristics(CC,HH,LL)

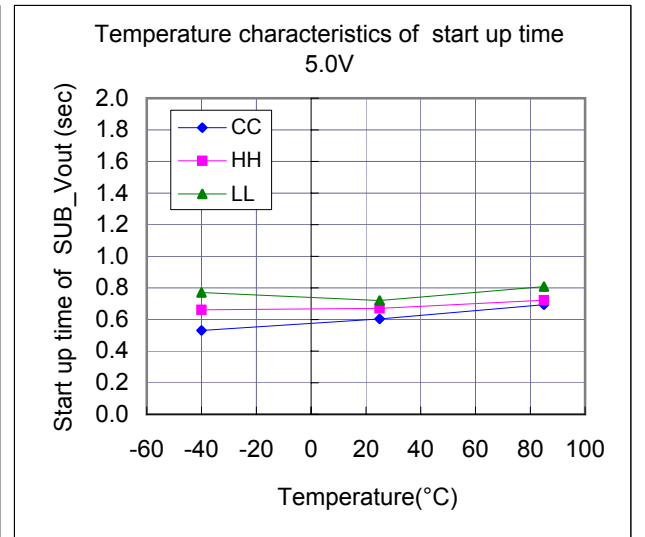
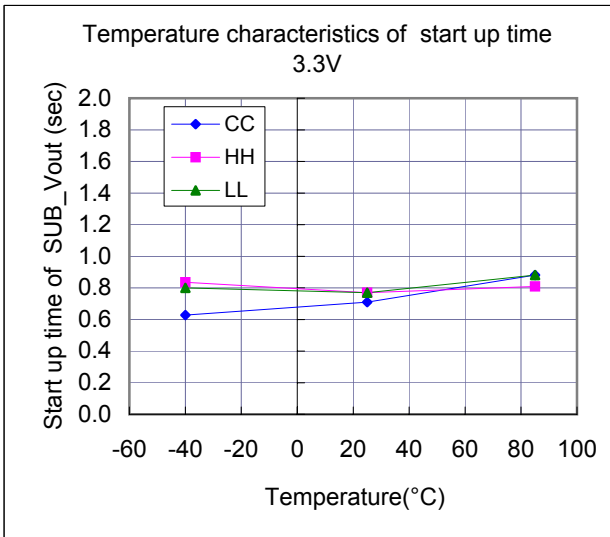
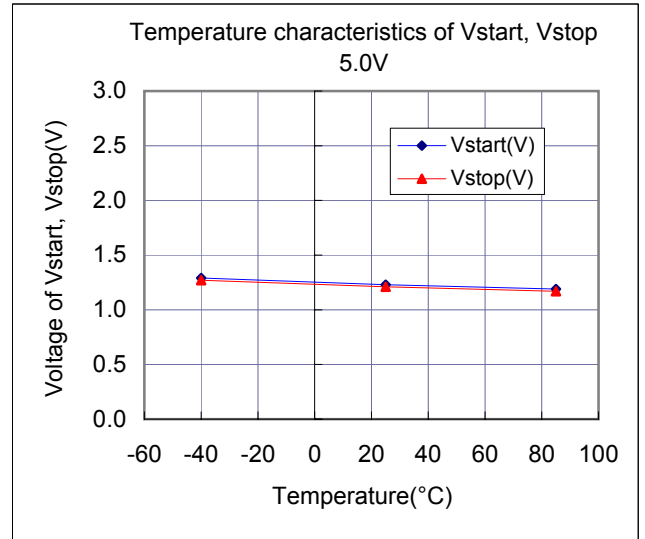
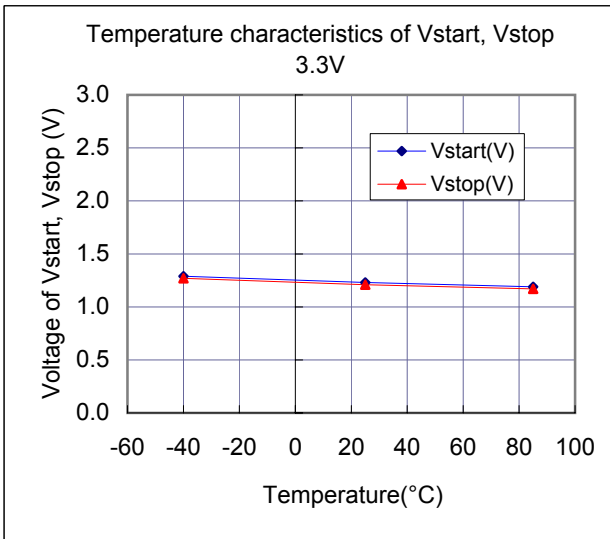
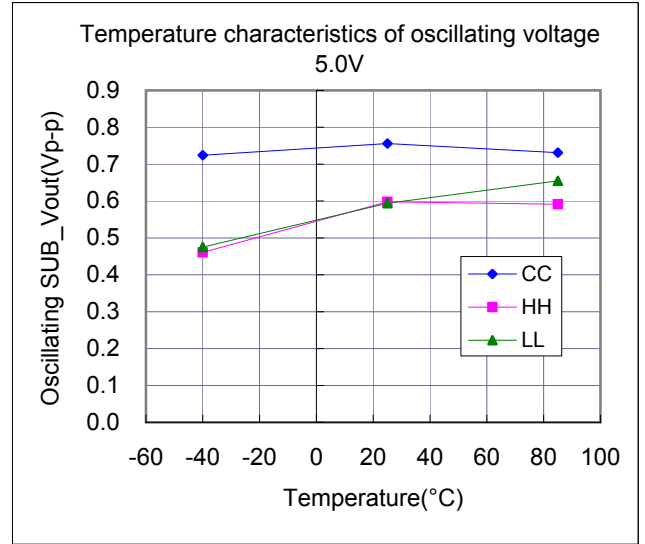
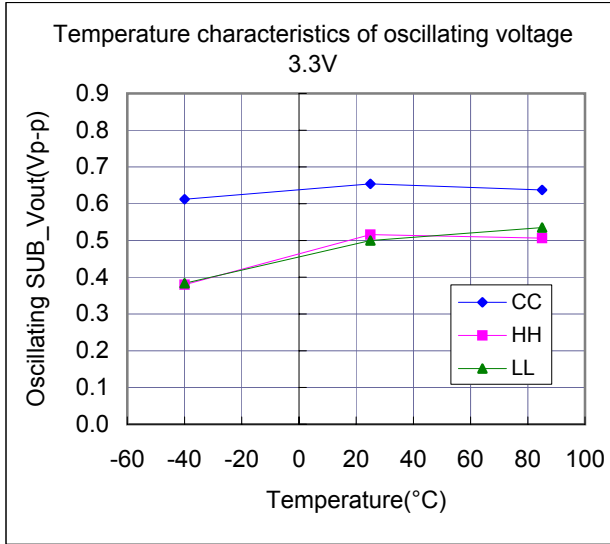

Evaluation of a Low Frequency Clock Oscillation Circuit

SSP-T7-FL 6.0pF with R5F2L36CANFP-64P [LQFP(10x10) 0.50mm pitch]

Measurement conditions : 3.3V ,5.0V



Low power consumption MPU

Referential components layout(see Figure 1)

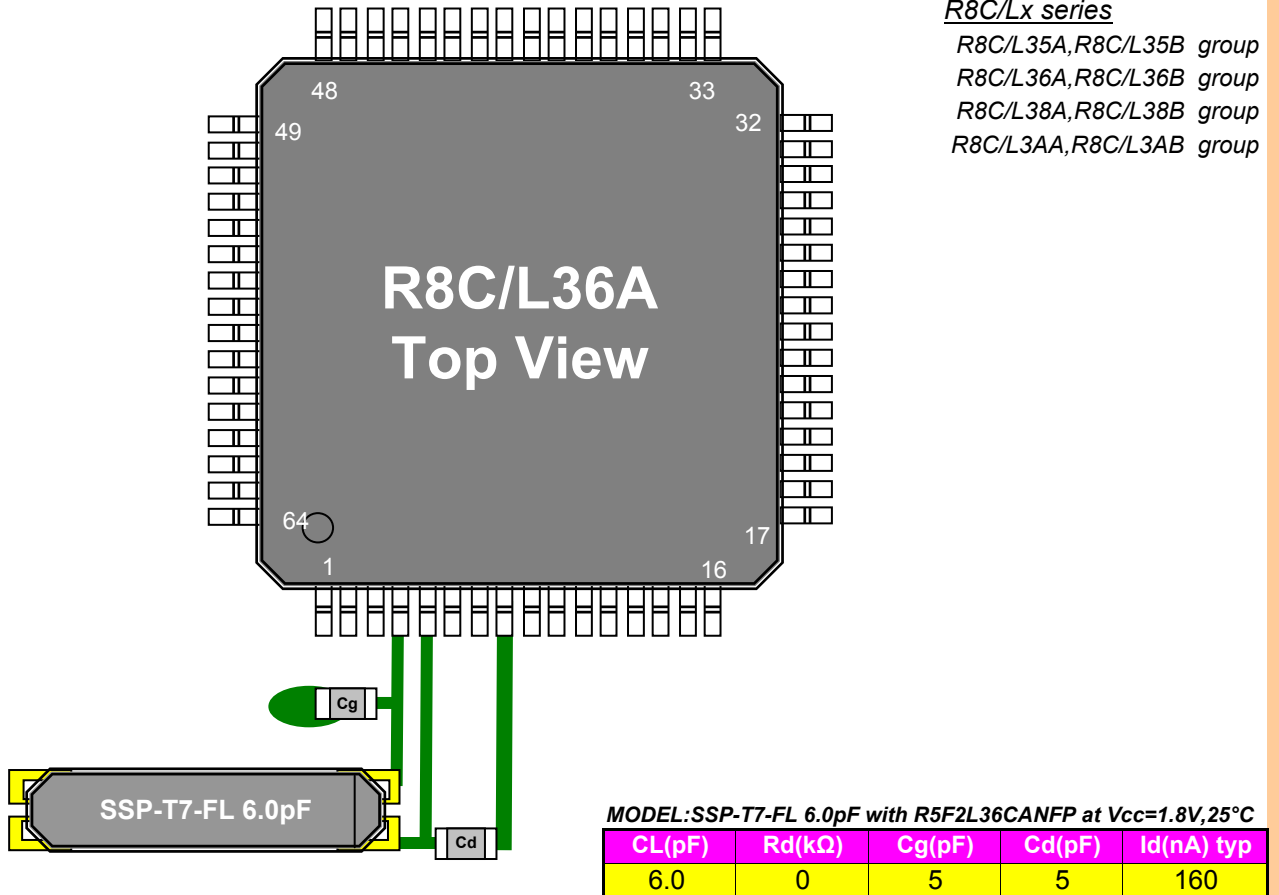

Figure 1 Referential components layout

Notes Board Design

When using a crystal resonator, place the resonator and its load capacitors as close as possible to SUB_in and SUB_out pins.

Other signal lines should be routed away from the resonator circuit to prevent induction from interfering with correct oscillation (see figure 2).

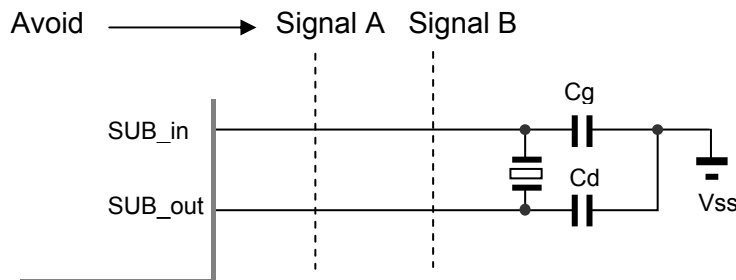

Figure 2 Example of Incorrect Board Design

Remark When using the subsystem clock, insert a resistor, Rd, in series on the SUB_out side.

Evaluation of a Low Frequency Clock Oscillation Circuit

SSP-T7-FL 6.0pF with R5F2L36CANFP-64P [LQFP(10x10) 0.50mm pitch]

Measurement conditions : 3.3V ,5.0V



Low power consumption MPU

[Evaluation Sample at 25°C]

SAMPLE	No.	CL(pF)	Fo(Hz)	fr(Hz)	R1(kΩ)	Co(pF)	C1(fF)	Q(k)
SSP-T7-FL	1	6	32768.02	32763.07	41.7	0.90	2.085	55.9
	2	6	32768.00	32763.06	42.6	0.90	2.081	54.8
	3	6	32768.01	32763.05	41.0	0.91	2.093	56.7

[IC Test Data : IC Sample Rd=0Ω,Cg=5pF,Cd=5pF at 25°C]

Vcc(V)	IC Sample	Fosc(Hz)	df / f(x10 ⁻⁶)	DL(μW)	-RL (kΩ)	Id (nA)	DC_Bias(V)	Vstart(V)	Ts(sec)
5.0	CC	32768.18	5.0	0.047	1054	252	0.94	1.23	0.60
	HH	32768.11	2.7	0.034	734	202	0.73	1.30	0.67
	HL	32768.15	3.9	0.025	804	173	0.72	1.32	0.69
	LH	32768.22	6.0	0.038	804	218	0.76	1.22	0.72
	LL	32768.19	5.1	0.032	804	198	0.65	1.28	0.72

[IC Test Data : IC Sample Rd=0Ω,Cg=5pF,Cd=5pF at 25°C]

Vcc(V)	IC Sample	Fosc(Hz)	df / f(x10 ⁻⁶)	DL(μW)	-RL (kΩ)	Id (nA)	DC_Bias(V)	Vstart(V)	Ts(sec)
3.3	CC	32768.14	3.6	0.036	904	220	0.87	1.23	0.71
	HH	32768.07	1.4	0.027	674	177	0.65	1.30	0.77
	HL	32768.10	2.4	0.019	674	149	0.64	1.32	0.76
	LH	32768.17	4.6	0.028	674	187	0.68	1.22	0.78
	LL	32768.14	3.8	0.024	674	167	0.57	1.28	0.77

Remark (see figure 3)

$$Fo = fr \times \{ C1 / (2 \times (Co + CL)) + 1 \} \text{ (Hz)}$$

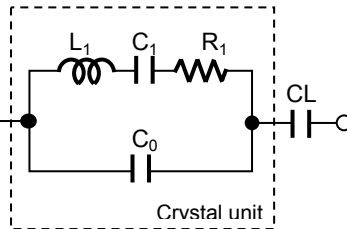

- Fo : Load resonance frequency
- fr : Resonance frequency
- R1 : Motional resistance
- C1 : Motional capacitance
- Co : Shunt capacitance
- CL : Load Capacitance

Figure 3 Equivalent circuit of crystal unit, and CL

Remark (see figure 4)

Approximate formula of the load capacitance of the circuit CL,

$$CL = Cg \times Cd / (Cg + Cd) + Cs \text{ (pF)}$$

$$Cs = Cgs \times Cds / (Cgs + Cds) + Cos \text{ (pF)}$$

where Cs(=3 to 5pF) stands for stray capacitance of the circuit.

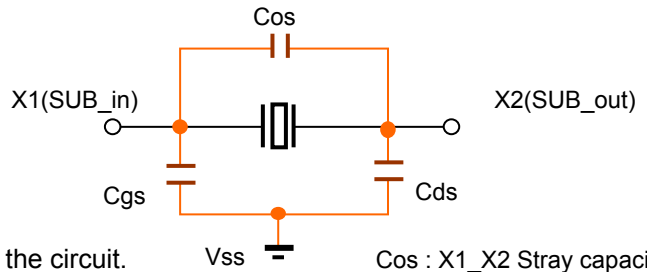

- Cos : X1_X2 Stray capacitance
- Cgs : X1_Vss Stray capacitance
- Cds : X2_Vss Stray capacitance

Figure 4 Stray capacitance Cos,Cgs,Cds of the circuit

Resonator circuit constants differ depending on the resonator element, stray capacitance in its interconnecting circuit, and other factors. Suitable constants should be determined in consultation with the resonator element manufacturer.

Evaluation of a Low Frequency Clock Oscillation Circuit

SSP-T7-FL 6.0pF with R5F2L36CANFP-64P [LQFP(10x10) 0.50mm pitch]

Measurement conditions : Vcc=1.8V to 5.5V at 25°C



Low power consumption MPU

Referential Data(1) : Voltage characteristics(CC,HH,LL,HL,LH)

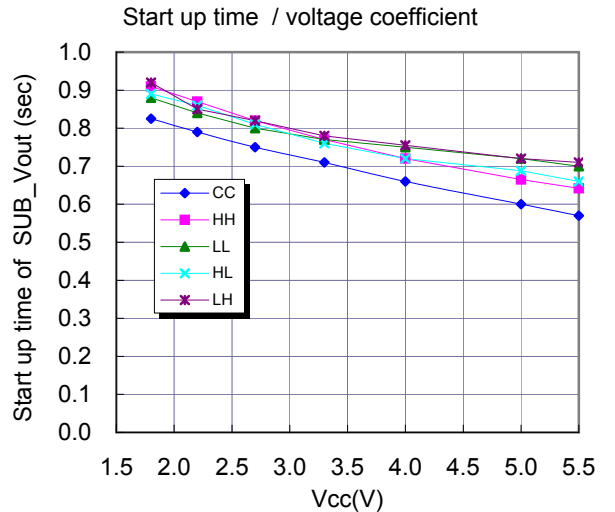
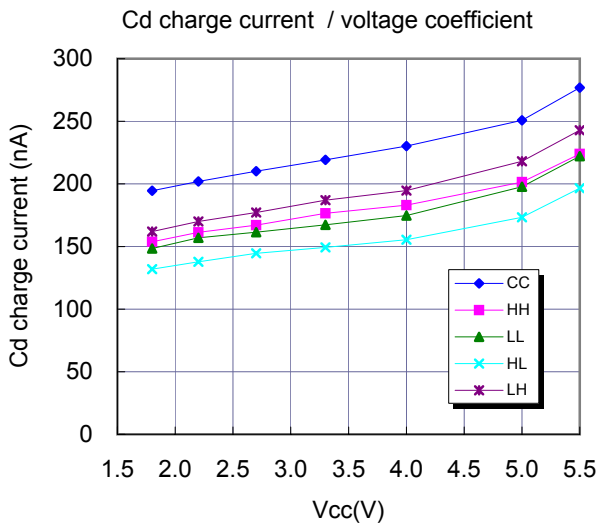
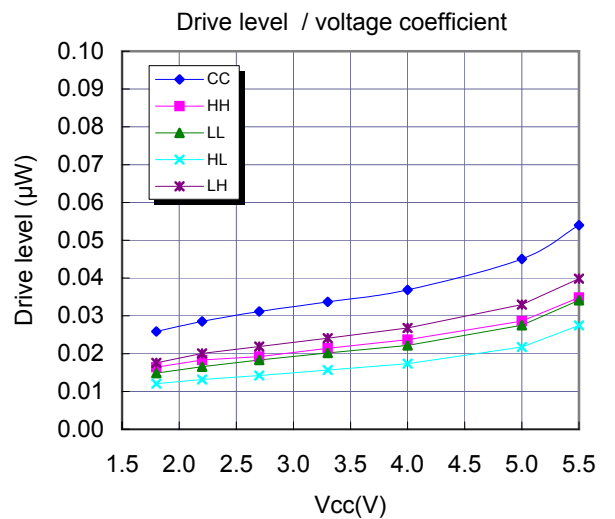
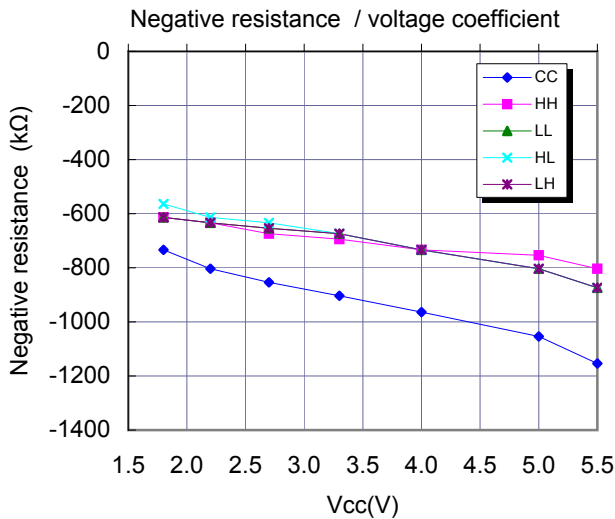
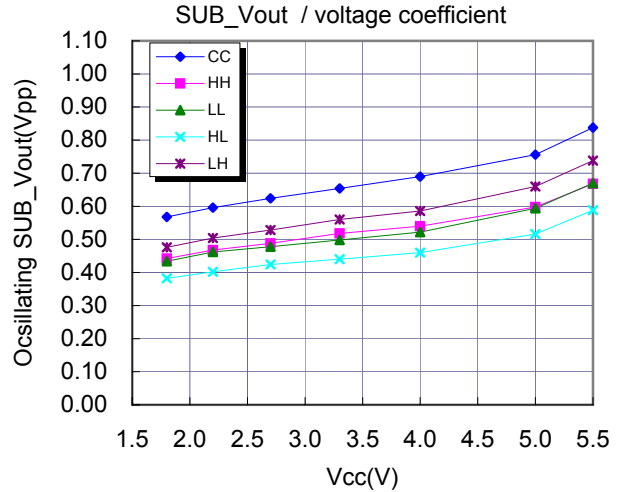
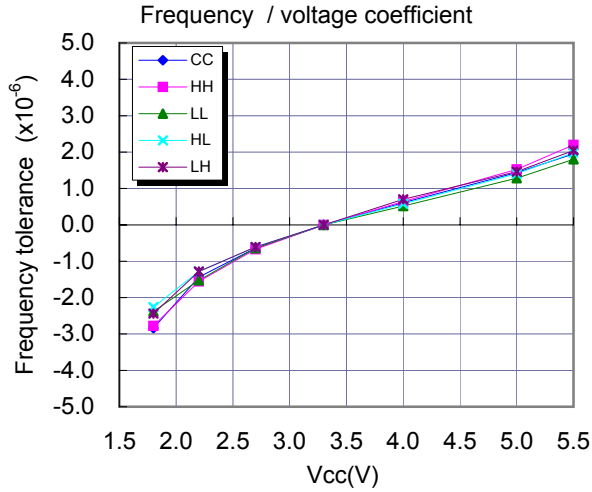

Evaluation of a Low Frequency Clock Oscillation Circuit

SSP-T7-FL 6.0pF with R5F2L36CANFP-64P [LQFP(10x10) 0.50mm pitch]

Measurement conditions : Vdd=3.3V,5.0V at 25°C



Low power consumption MPU

Referential Data(2) : Load capacitance characteristics(CC,HH,LL)

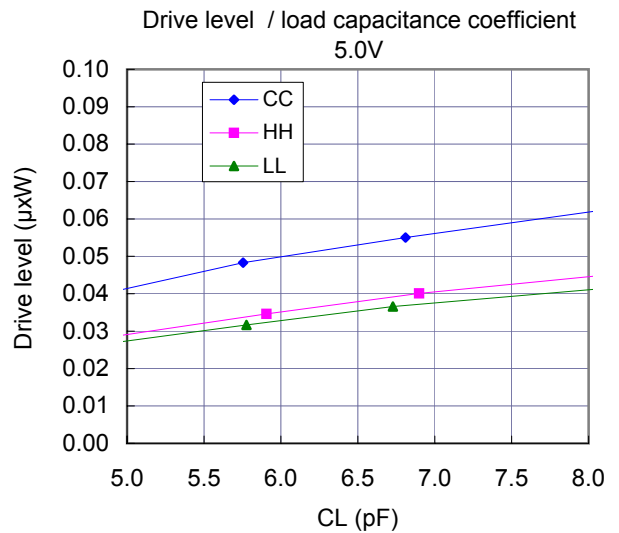
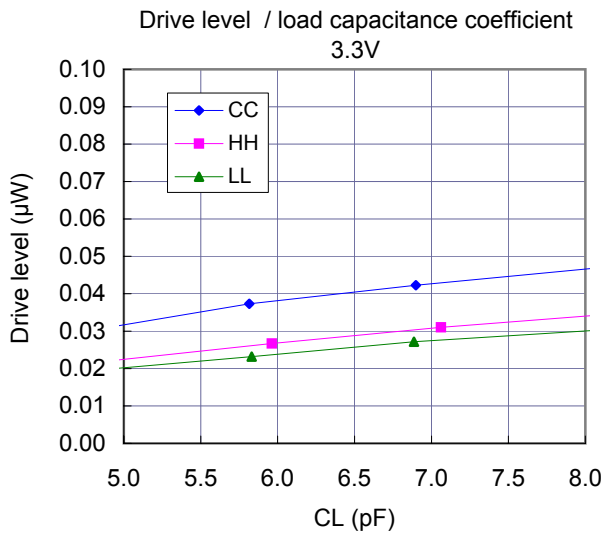
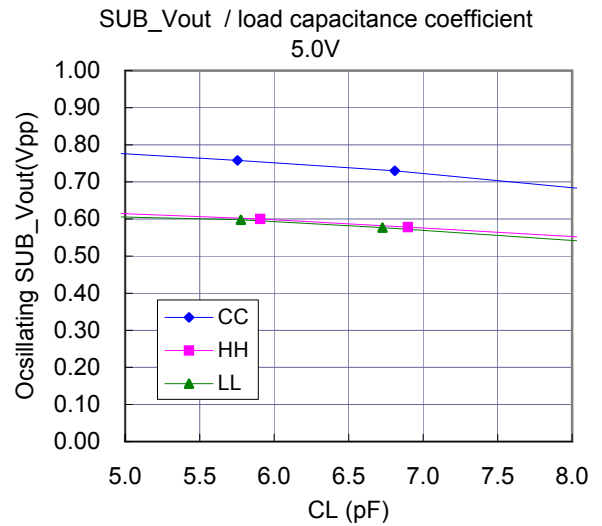
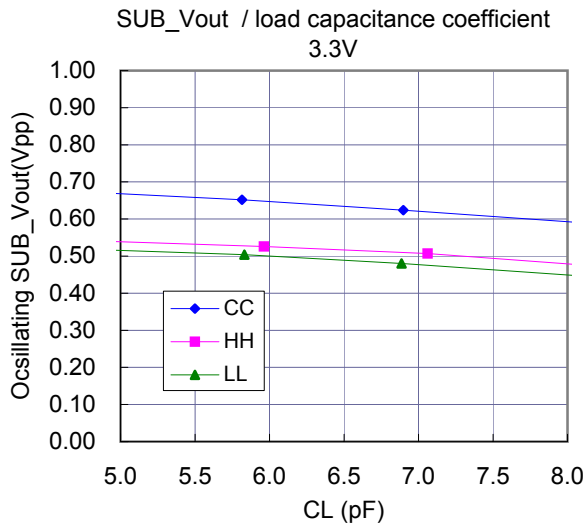
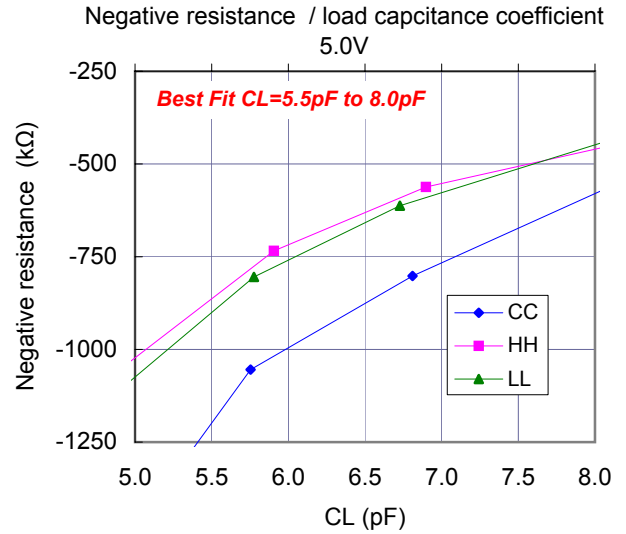
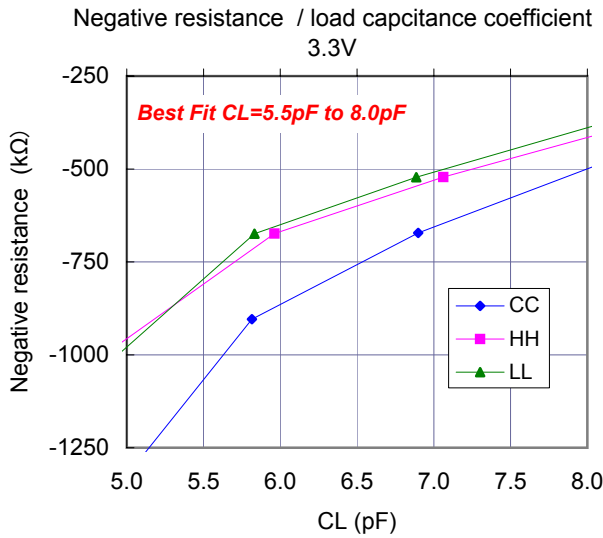

Evaluation of a Low Frequency Clock Oscillation Circuit

SSP-T7-FL 6.0pF with R5F2L36CANFP-64P [LQFP(10x10) 0.50mm pitch]

Measurement conditions : Vdd=3.3V,5.0V at 25°C



Low power consumption MPU

Referential Data(3) : Load capacitance characteristics(CC,HH,LL)

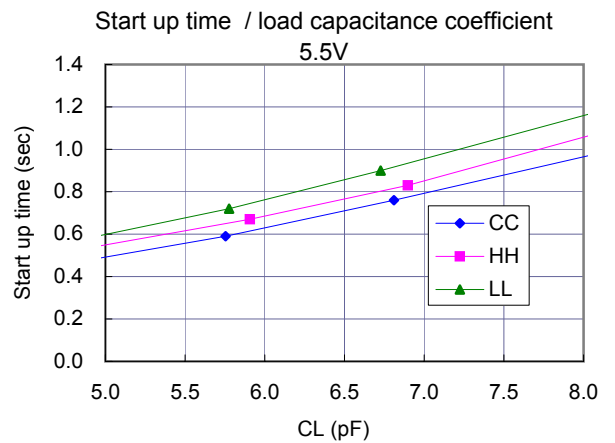
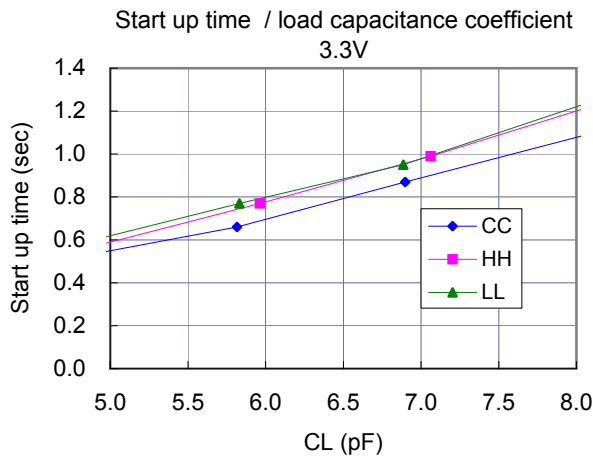
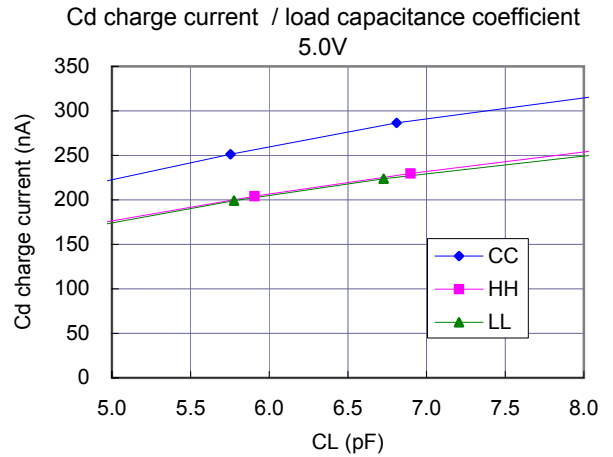
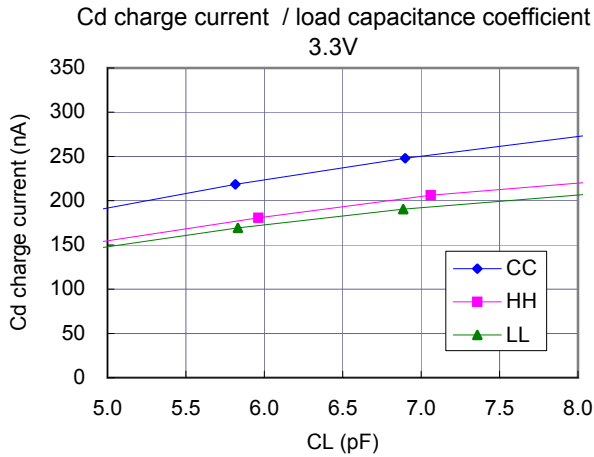

Low power consumption R8C/Lx and Low CL SSP-T7-FL 6.0pF

In addition, the SSP-T7-FL_4.4pF will be offered, realizing a 50% power consumption reduction in oscillation and a 2 x super high speed oscillation start-up time.



Table 1 XCIN oscillation circuit and load capacitance for a resonator

CL(pF)	Rd(kΩ)	Cg(pF)	Cg(pF)	Vcc (Cd charge current: Id)
6.0	0	5	5	3.3V(180nA typ),5.0V(210nA typ)
4.4	330	2	3	3.3V(100nA typ),5.0V(115nA typ)

*RENESAS MPU R8C/Lx group; R8C/L35x,R8C/L36x,R8C/L38x and R8C/L3Ax & SSP-T7 series

IC sample Rd=0Ω,Cg=5pF,Cd=5pF,CL=6.0pF

IC sample Rd=330kΩ,Cg=2pF,Cd=3F,CL=4.4pF

Vcc(V)	IC sample	M(times) [*]	Id(nA)	Ts(sec)	Vcc(V)	IC sample	M(times) [*]	Id(nA)	Ts(sec)
5.0	CC	16	252	0.60	5.0	CC	21	142	0.32
	HH	11	202	0.67		HH	16	113	0.37
	HL	12	173	0.69		HL	16	99	0.37
	LH	12	218	0.72		LH	16	121	0.42
	LL	12	198	0.72		LL	16	108	0.41
3.3	CC	14	220	0.71	3.3	CC	18	121	0.38
	HH	10	177	0.77		HH	14	96	0.44
	HL	10	149	0.76		HL	14	83	0.43
	LH	10	187	0.78		LH	14	103	0.46
	LL	10	167	0.77		LL	14	92	0.47

*R1max=65kΩ

*R1max=65kΩ

Evaluation of a Low Frequency Clock Oscillation Circuit

SSP-T7-FL 6.0pF with R5F2L36CANFP-64P [LQFP(10x10) 0.50mm pitch]

Measurement conditions : Vcc=(0.5V) to 5.5V at 25°C



Low power consumption MPU

Referential Data(4) : BC_Bias and Symmetry characteristics(CC,HH,HL,LH,LL)

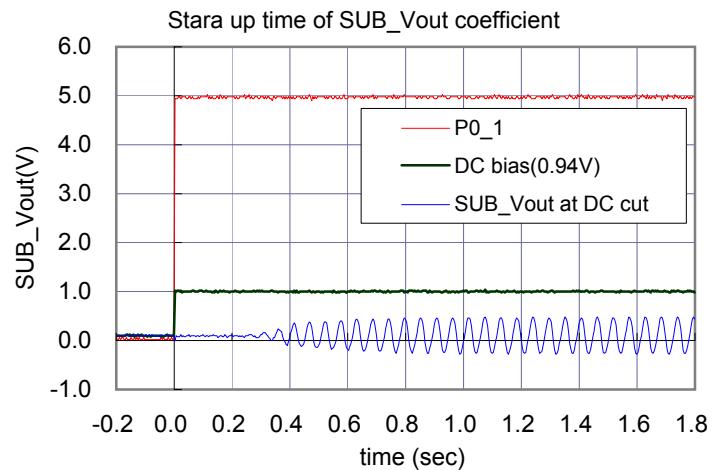
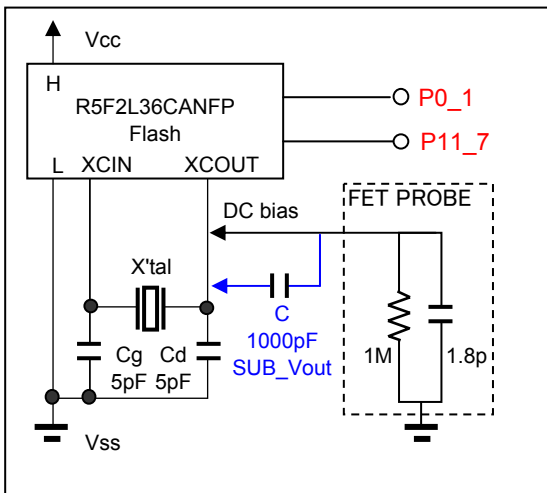
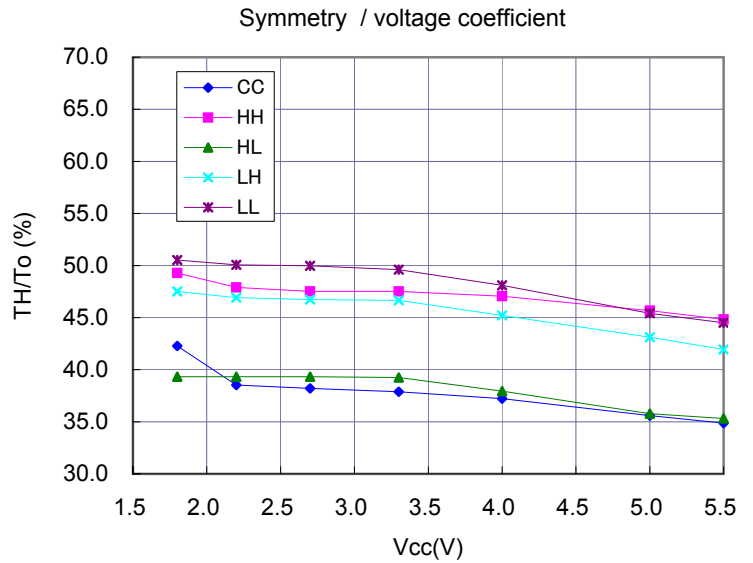
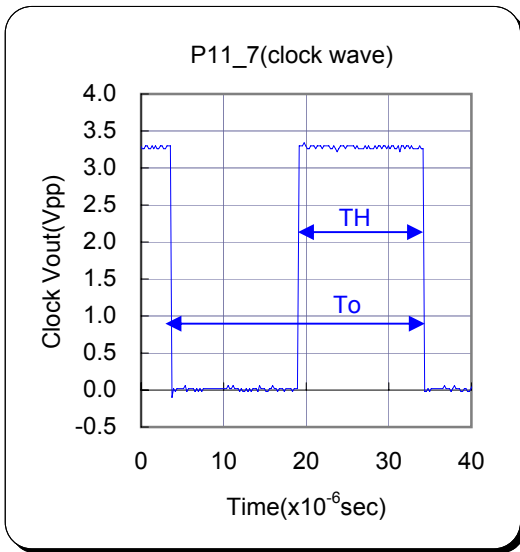
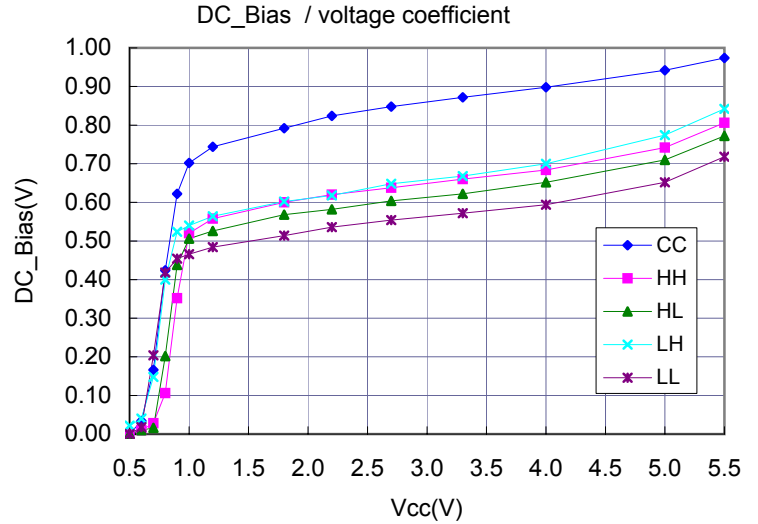
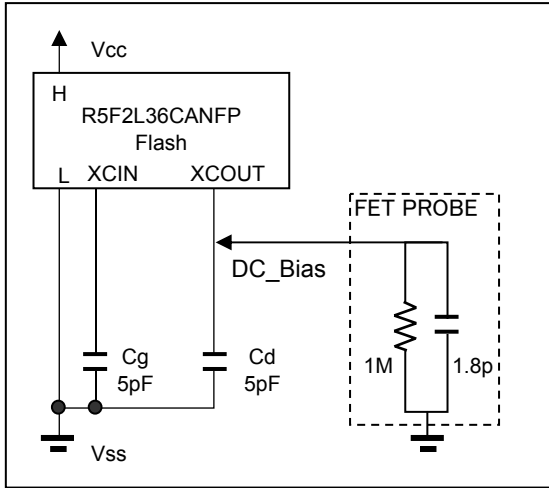

Evaluation of a Low Frequency Clock Oscillation Circuit

SSP-T7-FL 6.0pF with R5F2L36CANFP-64P [LQFP(10x10) 0.50mm pitch]

Measurement conditions : Vcc=5.0V



Low power consumption MPU

Referential Data(5) : SUB_signal wave characteristics(CC,HH,HL,LH,LL)

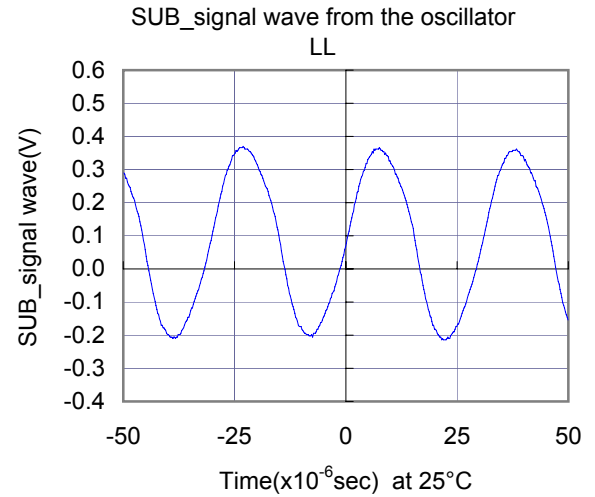
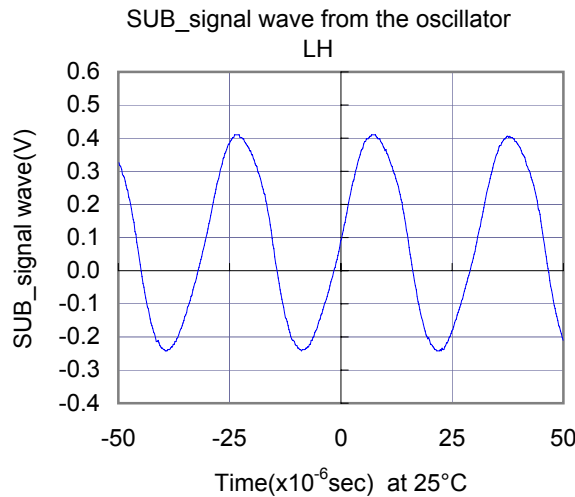
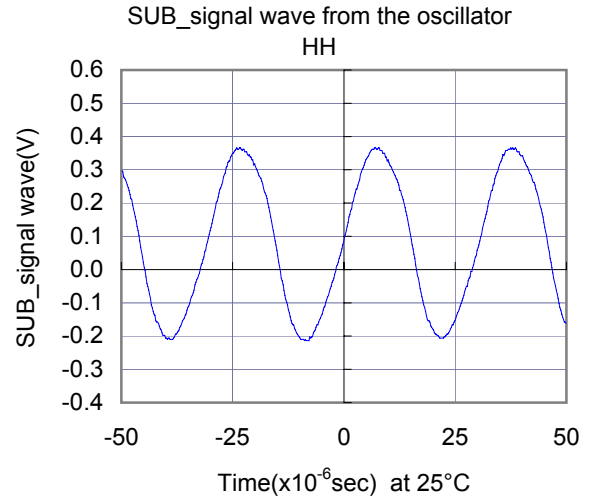
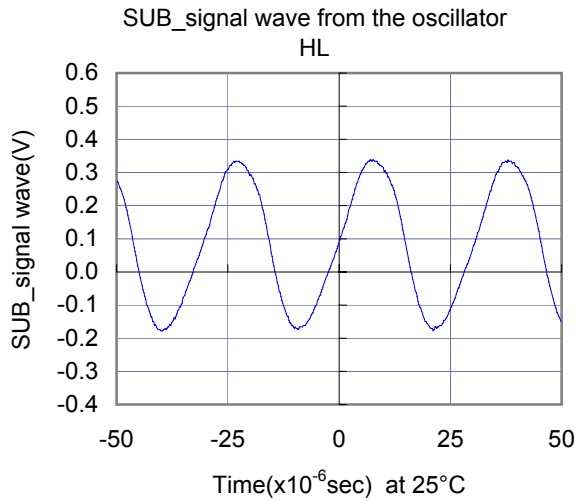
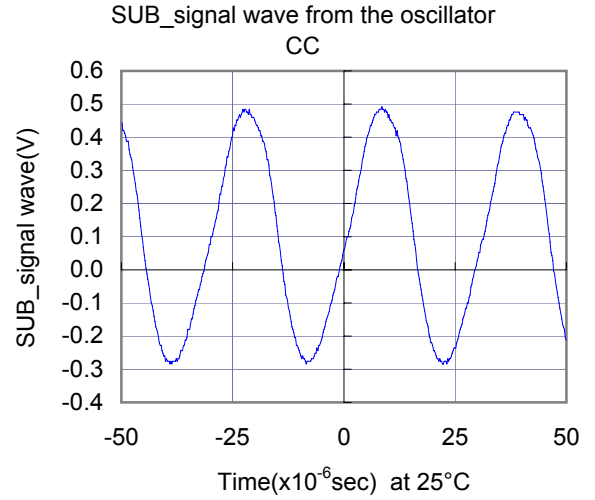
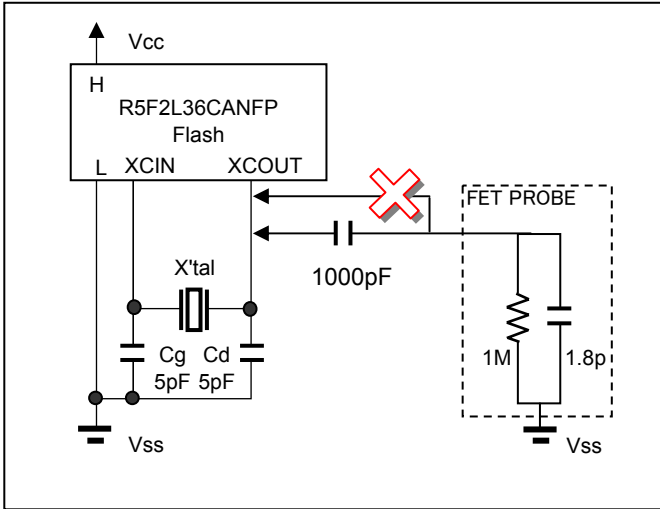

Evaluation of a Low Frequency Clock Oscillation Circuit

SSP-T7-FL 6.0pF with R5F2L36CANFP-64P [LQFP(10x10) 0.50mm pitch]

Measurement conditions : Vdd=3.3V,5.0V at 25°C



Low power consumption MPU

Referential Data(6) : Selection of XCIN oscillation mode and recommended load capacitance

For R8C/Lx series

XCIN oscillation circuit consists of an excellent power saving circuit which realizes stable oscillation at low amplitude.

RENESAS MPU R8C/Lx series

- R8C/L35A group, R8C/L35B group (52pin)
- R8C/L36A group, R8C/L36B group (64pin)
- R8C/L38A group, R8C/L38B group (80pin)
- R8C/L3AA group, R8C/L3AB group (100pin)

For your design reliability, please refer to Table 1 which shows the performance of the XCIN oscillation circuit and the recommended load capacitance for each resonator.

SSP-T7 series

SSP-T7-FL CL=3.7pF,4.4pF,6.0pF and SSP-T7-F CL=7.0pF,9.0pF

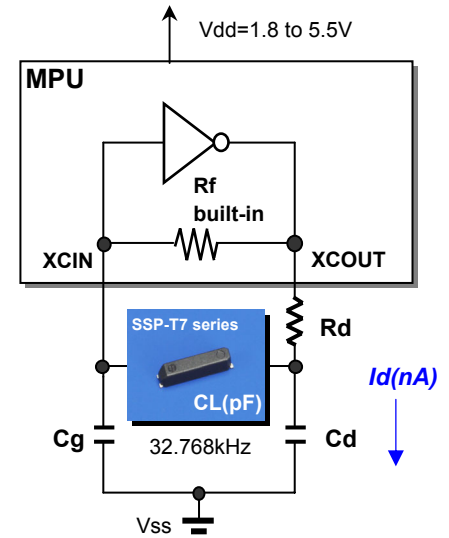

Table 1 XCIN oscillation circuit and load capacitance for a resonator

Resonator	Vcc	Recommended circuit constant and load capacitance for a resonator			
		Rd=330kΩ Cg=2pF,Cd=3pF	Rd=0Ω Cg=5pF,Cd=5pF	Rd=0Ω Cg=7pF,Cd=7pF	Rd=0Ω Cg=10pF,Cd=10pF
SSP-T7-FL <small>Low CL resonator</small>	5.0V	SSP-T7-FL 4.4pF <i>Id=120nA typ</i> <i>RL=-1110kΩ typ</i> <i>Ts=0.40sec typ</i>	SSP-T7-FL 6.0pF <i>Id=210nA typ</i> <i>RL=-840kΩ typ</i> <i>Ts=0.70sec typ</i>	-	-
	3.3V	SSP-T7-FL 4.4pF <i>Id=100nA typ</i> <i>RL=-960kΩ typ</i> <i>Ts=0.45sec typ</i>	SSP-T7-FL 6.0pF <i>Id=180nA typ</i> <i>RL=-720kΩ typ</i> <i>Ts=0.80sec typ</i>	-	-
SSP-T7-F <small>Existing product</small>	5.0V	-	-	SSP-T7-F 7.0pF <i>Id=245nA typ</i> <i>RL=-660kΩ typ</i> <i>Ts=0.85sec typ</i>	SSP-T7-F 9.0pF <i>Id=290nA typ</i> <i>RL=-400kΩ typ</i> <i>Ts=1.30sec typ</i>
	3.3V	-	-	SSP-T7-F 7.0pF <i>Id=215nA typ</i> <i>RL=-570kΩ typ</i> <i>Ts=0.95sec typ</i>	SSP-T7-F 9.0pF <i>Id=245nA typ</i> <i>RL=-340kΩ typ</i> <i>Ts=1.40sec typ</i>

Low power consumption R8C/Lx and SSP-T7-FL

